

### Package Contents

- Occupancy Sensor
- 2 screws, 2 wall anchors
- Wire bracket

### Tools Required

- Power drill, 3/16" bit
- Screwdriver
- Light meter
- Battery (CR2032) for testing

### Product Description

The ceiling-mounted Occupancy Sensor saves energy and adds convenience by accurately detecting when an area is occupied or vacant.

This device is wireless, powered by indoor light, and uses a passive infrared (PIR) sensor to detect motion. The occupancy sensor transmits RF signals to control lighting, HVAC and outlets more efficiently.

### Features Include:

- Sends wireless messages to other devices when motion is detected
- Harvests ambient solar energy to power the sensor and wireless communication
- Mounts easily on any ceiling material
- Works with other sensors for enhanced occupancy tracking
- Built-in tests to confirm operation at installed location
- Supplemental battery or alternative power supply options for extreme low-light conditions

### Specifications (typ. values)

Power Supply:	Indoor light energy harvesting
Optional:	Supplemental battery (CR2032) 2-wire connector for external power or remote solar cell (3-5 VDC)
RF Transmission Range	80 ft. (25 m)
Motion Sensing Range	34 ft. (10 m) diameter (refer to coverage diagrams)
Startup Charge Times*	(operation from empty energy storage)
First motion transmission / Linking	5 minutes @ 200 lux
Motion LED blink	1.5 hours @ 2000 lux
Light Test / Walk Test	
Sustaining Charge Time for battery free operation	3 hours per 24 hours @ 200 lux
Time to Full Charge*	25 hours @ 200 lux
Operating Life in Total Darkness	80 hours (after full charge)
Minimum Operating Light	50 lux (for auto-off only)
Optional Battery Life:	
• Infrequent Bright Light	20 yrs (with 200 lux for 2 hrs/day, 7 days/week)
• Consistent Low Light	15 yrs (with 65 lux for 5 hrs/day, 7 days/week)
• Total Darkness	6.5 yrs
Motion Transmission Interval	2 minutes
Unoccupied Transmission	10 and 30 minutes since last motion
Heartbeat Transmission Interval (unoccupied)	Disabled by default Enabled = heartbeat @ 1 hr interval (after unoccupied messages)
EnOcean Equipment Profile	A5-07-01 (EEP)
RF Communications	EnOcean 902 MHz
Dimensions	6.30" L x 2.35" W x 1.47" D (160mm x 60mm x 37mm)
Weight	4.4 oz. (125 g)
Mounting Height	7-10 feet (2 - 3m) recommended
Environment	Indoor use only 14° to 104°F (-10° to 40°C) 20% to 95% relative humidity (non-condensing)
Agency Compliance	FCC, IC, RoHS, CE, R&TTE

\* Natural bright light (2000 lux) or a battery can be temporarily used to significantly shorten startup charge times. Specified lux values are for typical fluorescent lighting. Lux level requirements for LED and other types may vary. For lux reference, OSHA standards require a minimum of 323 lux for office areas.

## Functional Description

If motion is detected by the permanently active PIR sensor, a radio telegram indicating the occupied status will transmit immediately. A transmission interval timer starts to run with a 2 minute lockout timer. No radio telegrams will be sent out until the timer expires.

After the timer has expired, the unit will transmit occupancy upon new motion detection. An unoccupied message will be sent if no motion is detected for an extended period - sending the first at 10 minutes, then again at 30 minutes. A heartbeat message can also be enabled.

## 1) Planning

Take a moment to plan for the sensor's successful operation and optimal communication with other system components.

Remove the sensor from its packaging and place it under a bright light to provide the required startup charge. Optionally, to ensure the sensor energy storage is fully charged, insert a CR2032 battery for 5 minutes while in a well-lit location.

- Ensure the location provides consistent and adequate light
- Locate the sensor between 7 - 10 ft (2.1 to 3 m) high
- Avoid installed near ceiling fan or hanging light fixtures
- Consider the area's traffic patterns and principal use, for example, walking, working, lounging or sleeping
- Provide a minimum clearance of 4 ft. (1.2 m) away from heat sources, light bulbs, forced air, or ventilation systems
- Consider the construction materials (such as metal) in the space and obstacles that may interfere with RF signals

## Sensor Range

A single occupancy sensor provides sufficient coverage for most applications. For some applications, multiple sensors may be required to provide complete coverage. Furnishings and Building Architecture in the sensor range can reduce coverage.

## Coverage Diagrams

Top View

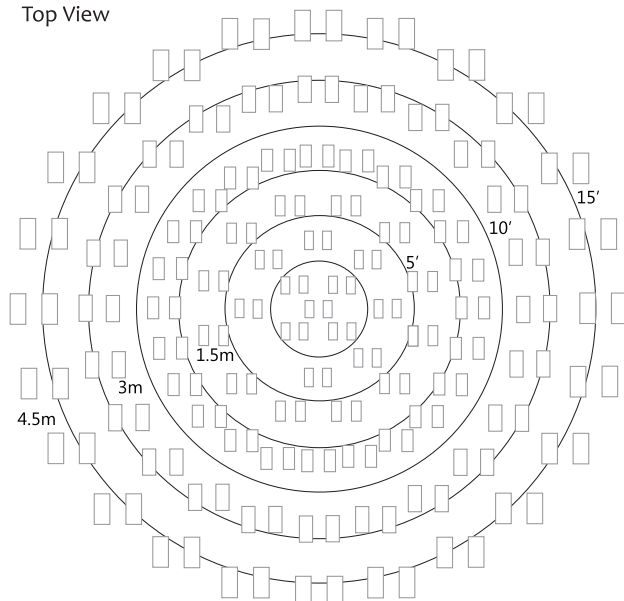

Side View

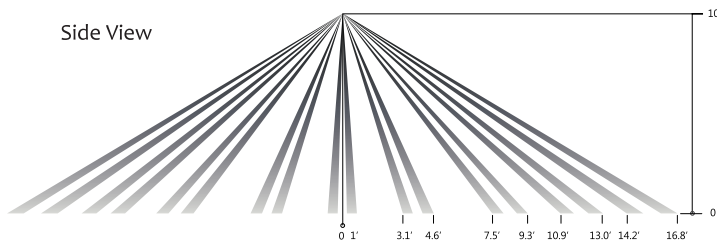

To provide coverage for very high ceilings, a wall sensor can be incorporated in the plan for complete coverage.

## 2) Installing

estimated time: 20 minutes



The occupancy sensor can be mounted on most ceilings with the provided screws, or mounted on dropped ceilings, using the provided wire bracket.

*NOTE: It is often easier to link the sensor before it is mounted on the ceiling. Refer to the "Linking" section.*

1. Decide where you want to install the occupancy sensor.  
*Tip:* For visual alignment, orient the sensor parallel to one of the walls.
2. Remove the mounting plate from the sensor.
3. Decide which of the two installation options is appropriate.

### A. Screw Mounting Plate to the Ceiling

- i. Hold the mounting plate in place on the ceiling and use a pencil to lightly mark two small dots for the screw drill points.
- ii. Drill two holes with a 3/16" drill bit and insert the wall anchors.
- iii. Insert the first screw loosely and level the mounting plate.
- iv. Insert the second screw and then hand-tighten the first screw.

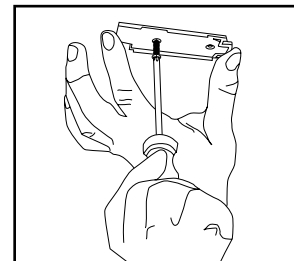

### B. Mount Using the Wire Bracket

- i. Remove the ceiling tile where you want to mount the sensor.
- ii. Place the mounting plate squarely on the ceiling tile and use the wire to mark two points for the holes.
- iii. Punch two small holes through the ceiling tile at the marked points.
- iv. Insert the wire bracket through the two holes in the mounting plate.

Make sure the ends are roughly even.

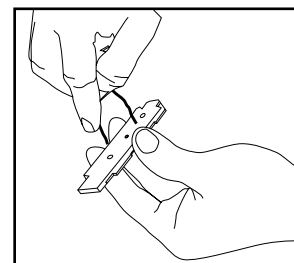

- v. Feed the wires through the holes in the ceiling tile.

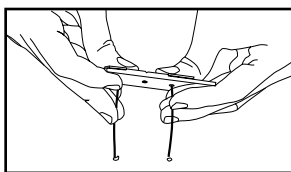

- vi. On the front of the ceiling tile, flatten the wire bracket so it is snug against the mounting plate.

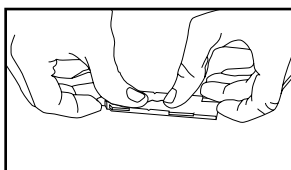

- vii. On the back of the ceiling tile, twist the wires together to hold the mounting plate securely.

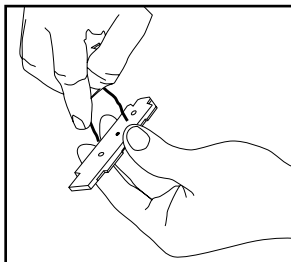

- viii. Replace the ceiling tile.

4. Attach the sensor to the mounting plate:

With the 2-button interface facing you, slide the sensor to the left on the mounting plate until it snaps into place.

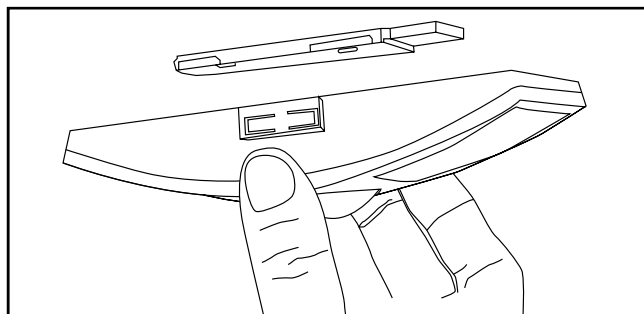

5. Confirm the sensor is properly positioned to detect motion and has sufficient light to operate - refer to the “Walk Test” and “Light Test” sections.

### 3) Linking

Two or more compatible devices can be linked and configured to provide the desired control. There are two basic types of devices in the system; transmitters and transceivers.

- **Transmit-only:** Transmitters are simple energy-harvesting devices that send RF messages to communicate a condition, level, or state. Transmitters can only be linked to transceivers.  
Examples > Rocker Switches, Occupancy Sensors
- **Transmit & Receive:** Transceivers are controlling devices that send as well as receive RF messages. They also process relevant control logic, and actuate the appropriate outputs (switching a light on or off for example). Transceivers can be linked with transmitters as well as other transceivers.  
Examples > Relays, Dimmers, Gateways

### The Occupancy Sensor is a Transmit-only Device.

To link the occupancy sensor to a transceiver; the transceiver must first be powered, within wireless range of the sensor, and set to accept links.

Next, the desired transmitter, or another transceiver, is triggered to send a special link message. The awaiting transceiver receives and stores the link permanently so the devices can interact to provide a variety of intelligent control options.

### To Link or Unlink an Occupancy Sensor

1. Set the desired transceiver to the desired Link/Unlink mode. (refer to that device’s installation guide).
2. Click the Menu (O) button on the bottom of the sensor once. This sends a link/unlink radio telegram.

*NOTE: The button interface on the sensor is used for linking and testing only. The occupancy timer settings are configured on the transceiver to which the sensor is linked.*

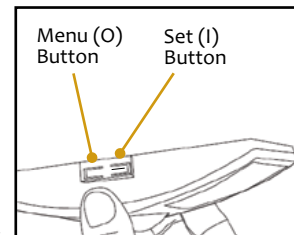

**Refer to the “Linking” section of the transceiver/controller installation guides to complete the linking & setup process.**

### Testing the Sensor

Before starting a test, ensure the sensor’s energy storage is fully charged by placing it under bright light (2000 lux) for 1.5 hours, or insert a battery for 5 minutes while in a well-lit area.

*NOTE: If the sensor does not have a sufficient charge, it cannot enter into the test modes. No LED light or 1 red blink when the set button is pressed indicates insufficient charge.*

If a battery is used to charge the sensor for a light test, ensure it is removed to get an accurate light measurement.

A test mode will stay active for 3 minutes. To exit a test and resume normal operation, press and hold the Menu button for 5 seconds.

### Walk Test

Use the walk test to confirm that motion is within the sensor’s range.

1. Press and hold the Set button for 5 seconds.
  - > Red LED will blink to confirm that a walk test is active.
2. Move in and out of the sensor’s range to determine its coverage area.
  - > Sensor will blink when it detects motion.
3. Make small hand movements just inside the limit of the sensor’s range to see if the motion triggers a response.

*NOTE: Ensure the sensor does not falsely trigger from user activity outside the desired zone or other heat and motion sources. If false triggering occurs, adjust the sensitivity switch (next to the battery slot) from REG to LOW.*

## Light Test

Use the light test to measure real-time light levels and confirm whether the occupancy sensor has sufficient light.

1. Create a realistic lighting condition (the test measures the real-time light level).
2. Press and hold the Set (I) button for 10 seconds.
  - > Red & green LEDs will blink to confirm light test is active.
3. Watch the LED blink rate to determine the light strength.
  - > The highest is 5 blinks which indicates very good light (200 lux or more). 1 blink indicates minimum light (<25 lux).

*NOTE: If there is no blink rate, consider relocating the sensor or installing a battery to provide supplemental power.*

## Optional Settings

Two additional settings can be configured via button presses which may be useful in some installations. Note that these settings consume additional energy and are not advisable for low-light level installations:

**LED Blink on Motion Transmission** - Red LED under PIR lens will blink whenever motion is transmitted (disabled by default).

••> To enable/disable - press and hold Menu (O) button for 3 seconds (green Menu (O) LED will blink once)

- Enabled = 3 blinks from green Menu LED
- Disabled = 3 blinks from red Set LED

**Heartbeat Transmission** - unoccupied heartbeat message will be sent at 1 hr intervals with no motion (disabled by default).

••> To enable/disable - press and hold Menu button for 5 seconds (both green and red LEDs will blink once)

- Enabled = 3 blinks from green Menu LED
- Disabled = 3 blinks from red Set LED

## Supplemental Power (optional)

In areas with consistently low lighting, or prolonged periods of darkness, battery power (CR2032) or an auxiliary 3-5 VDC power source can be used to supplement the solar energy harvester.

1. Remove the sensor from the mounting plate and identify the battery holder and auxiliary power connector on the circuit board

2. A. Insert the battery under the clip with the positive pole (+) up and press it in place
3. B. Or insert the 3-5 VDC + and - leads into the appropriate screw terminals.
4. Remount the sensor on the mounting plate.

## Troubleshooting

Problem	Solution Checklist
Sensor does not generate a wireless message	<ul style="list-style-type: none"> <li>▪ Press Set (I) button to transmit motion message</li> <li>▪ Verify the LED blinks when motion is detected during a walk test</li> <li>▪ Verify the solar cell is charged properly</li> </ul>
Sensor is activated when there is nothing to detect	<ul style="list-style-type: none"> <li>▪ Verify there is 4 ft. (1.2 m) clearance from heat sources that may disturb sensing</li> <li>▪ Reduce sensitivity setting by moving the PIR sensitivity switch on the back from REG to LOW (the left-hand position)</li> </ul>
Linked device does not respond to wireless messages	<ul style="list-style-type: none"> <li>▪ Force motion message by pressing Set (I) button</li> <li>▪ Check for environment or range issues</li> <li>▪ Verify the device is linked</li> <li>▪ Check the transceiver connection and the wiring for errors</li> <li>▪ Check if appropriate devices are linked according to good system planning</li> </ul>
Explanation of Occupied & Heartbeat Message Data Telegrams	Data Byte 3: Super Capacitor Voltage, 0-250 (0-5V) Data Byte 2: Solar Panel Current, 0-127 microA Data Byte 1: 0xFF (occupied) or 0x00 (unoccupied) Data Byte 0: 0x09 (wall sensor) 0x0B (ceiling sensor)



contains:  
902 MHz: FCC: SZV-STM300U  
IC: 5713A-STM300U

This device complies with part 15 of the FCC rules and Industry Canada ICES-003. Operation is subject to the following two conditions: (1) This device may not cause harmful interference, and (2) this device must accept any interference received, including interference that may cause undesired operation.

**IMPORTANT!** Any changes or modifications not expressly approved by the party responsible for compliance could void the user's authority to operate this equipment.

Le présent appareil est conforme aux CNR d'Industrie Canada applicables aux appareils radio exempts de licence. L'exploitation est autorisée aux deux conditions suivantes: (1) l'appareil ne doit pas produire de brouillage, et (2) l'utilisateur de l'appareil doit accepter tout brouillage radioélectrique subi, même si le brouillage est susceptible d'en compromettre le fonctionnement.

**IMPORTANT!** Tous les changements ou modifications pas expressément approuvés par la partie responsable de la conformité ont pu vider l'autorité de l'utilisateur pour actionner cet équipement.

